

PB-22E32 (SELF-LOCK)

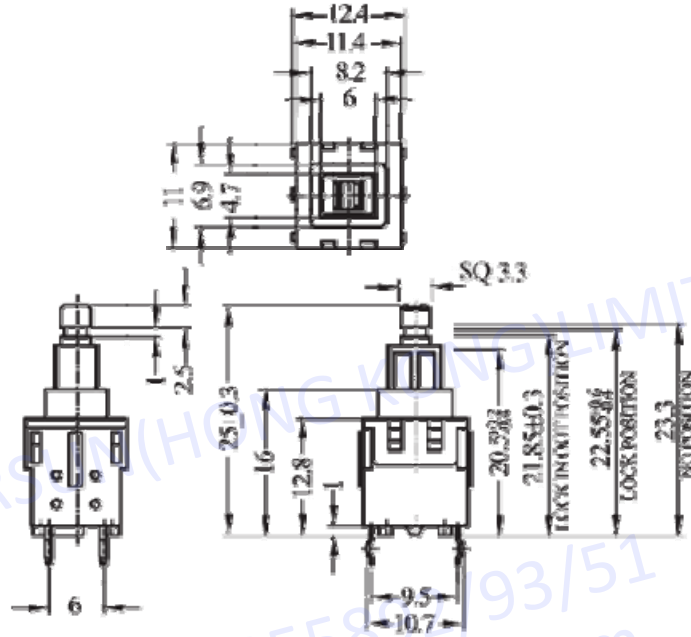

CIRCUIT DIAGRAM

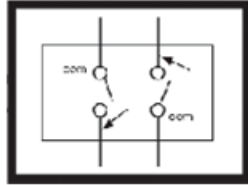

RATING: DC 12V 3A

垂直推动开关主要技术特性

The Main Technical Characteristics of Vertical Push Switch

额定负荷	DC 12V 3A	操作温度	-16°C to 60°C
Rated Load		Operating Temperature	
接触电阻	< 30 mΩ	寿命	10,000 次
contact Resistance		Life Test	
绝缘电阻	> 100 MΩ	作用力	350gf ± 150gf
Insulation Resistance		Operating Force	
耐电压	500V 0.5mA/min		
Dielectric Strength			