

TD-609XA

CIRCUIT DIAGRAM

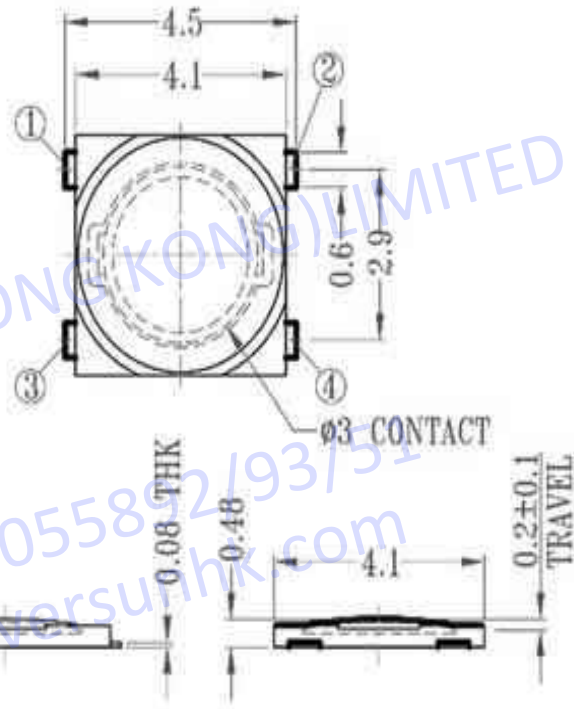
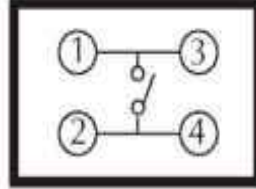

RATING: DC 12V 50mA